

A105G03

printed on: 13-04-2026



TECHNICAL INFO

Media type	INORGANIC FIBERGLASS
Efficiency	<math> < 4 \mu\text{m}_{(c)} \beta_x \geq 200 </math>
Efficiency 1	$5 \mu\text{m}_{(c)} \beta_x \geq 1000$
Max working pressure	12 bar
Seals	NBR
Temperature range	-30°C +100°C

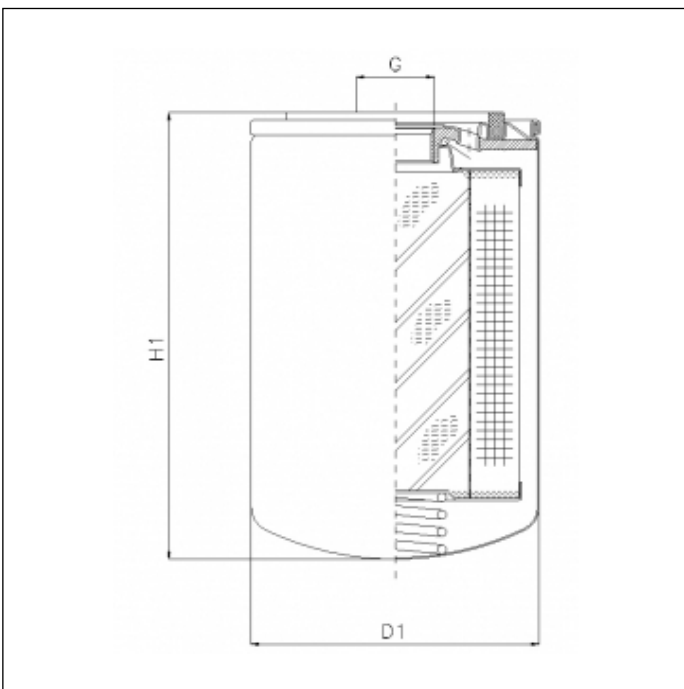

OVERALL DIMENSIONS

D1	96,0 mm
H1	60,0 mm
G	G 3/4

Technical information may change without notice. Image and drawing are representative only