

RHR60S25B6/AB1

printed on: 29-04-2025



TECHNICAL INFO

Media type	WIRE MESH
Efficiency	25 µm
Flow direction	OUT-IN
Collapse Δp	20 bar
Bypass setting	6.0 bar
Seals	NBR
Temperature range	-30°C +100°C

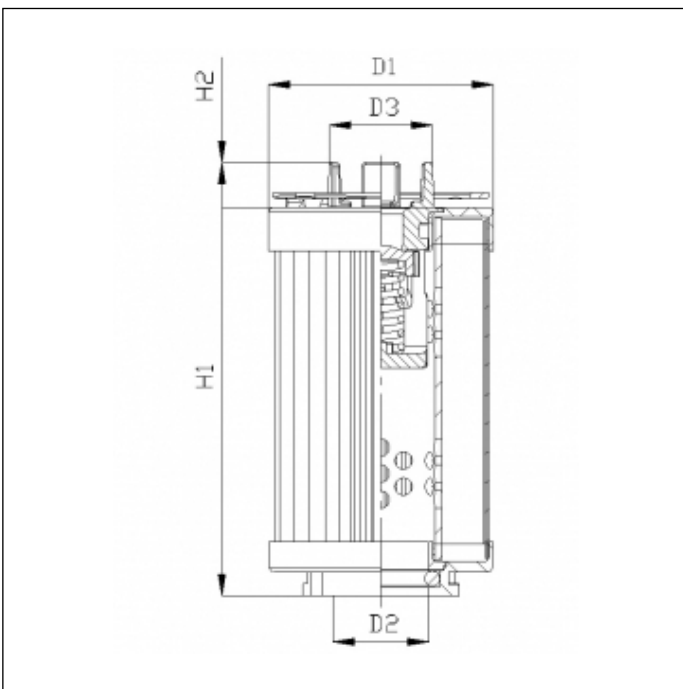

OVERALL DIMENSIONS

D1	52,0 mm
D2	22,2 mm
D3	24,0 mm
H1	100,0 mm
H2	10,3 mm

Technical information may change without notice. Image and drawing are representative only